

AIR CONDITIONING SYSTEMS

MULTI SPLIT SYSTEM

• SERVICE MANUAL

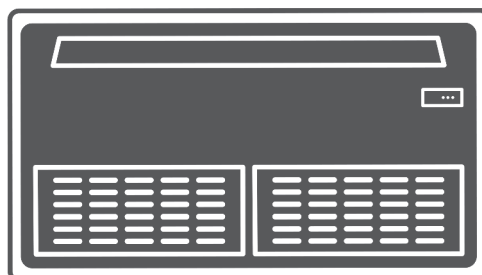
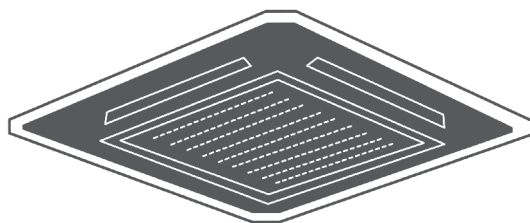
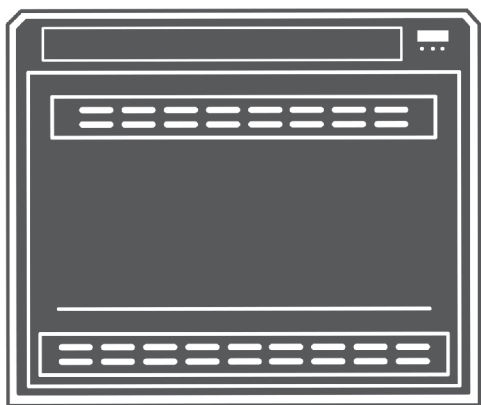

MODELS:

LV5MLI32-12,
LV5MCI32-12WiFiR,
LV5MCI32-18WiFiR,
LV5MDI32-12WiFiR



CONTENTS

1. General information of Indoor Units.....	1
2. Features	2
3. Dimensions	8
4. Service Space (unit: mm)	11
5. Wiring diagram	13
6. Static Pressure (Duct).....	15
7. Operation temperature range.....	16
8. Electronic function.....	17
8.1 Abbreviation	17
8.2 Icon explanation on indoor display board.....	17
8.3 Main Protection	18
8.4 Operation Modes and Functions	18

1. General information of Indoor Units

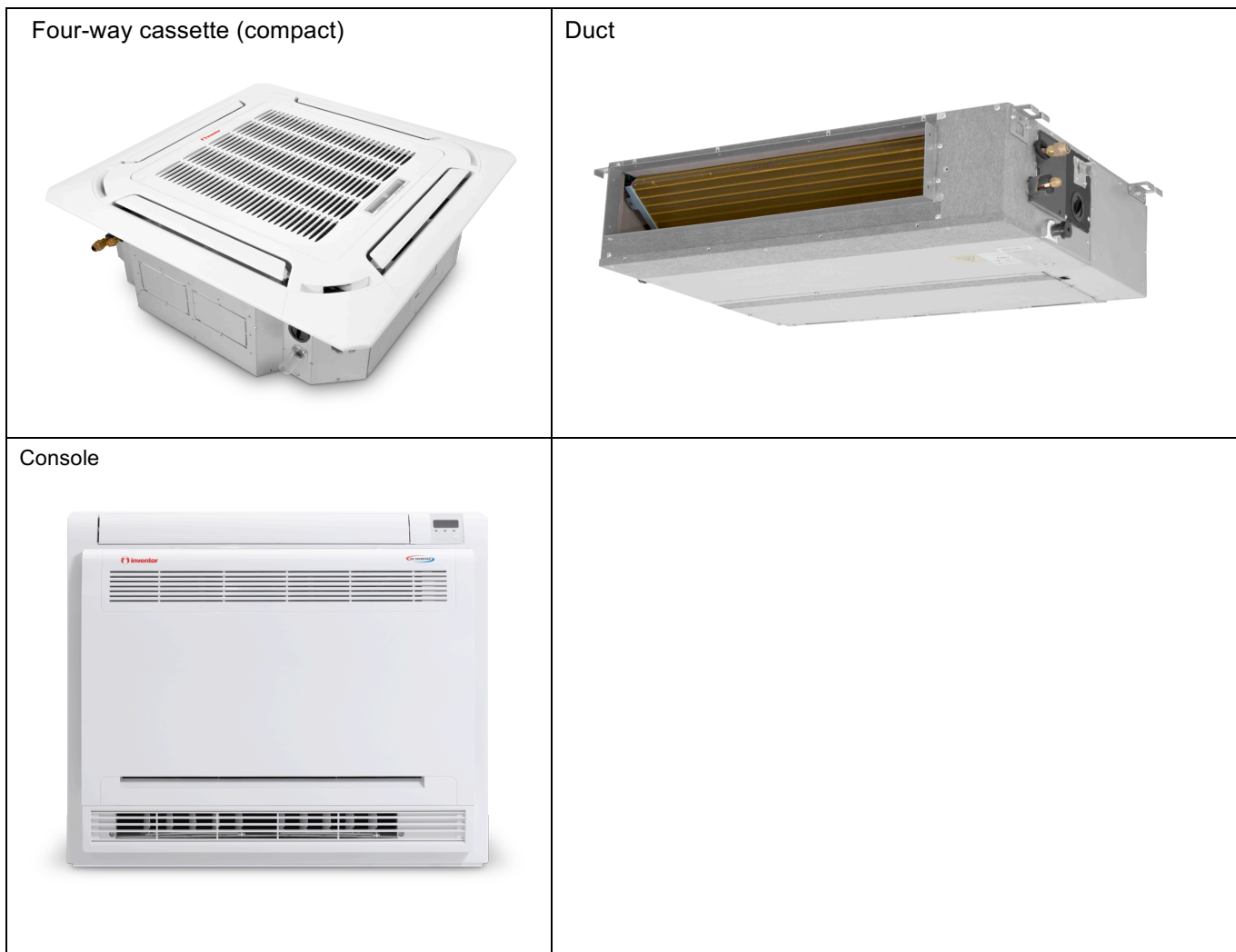

Model		
Four-way cassette (compact)	Duct	Console
LV5MCI32-12WiFiR , LV5MCI32-12WiFiR	LV5MDI32-12WiFiR	LV5MLI32-12

2. Features

2.1 Four-way cassette type(compact)

(1) New panel

- 360°surrounding air outlet design, affords comfortable feeling

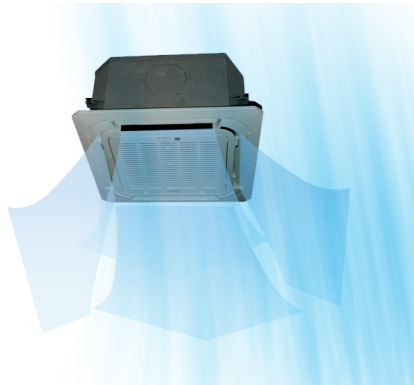

(2) Compact design

- The body size is 570×260×570mm, it's just smaller than the ceiling board, so it's very easy for installation and will not damage the decoration. The panel size is 647×50×647mm.
- The hooks are designed in the four corners of the body, which can save installation space.



(3) Electric control box built-in design

- The E-box is simply and safely built inside the indoor unit. It's convenient for installation and maintenance. Can check the control part easily, you only need to open the air return grille.



(4) Fresh air intake function:

- Fresh air fulfills air quality more healthy and comfortable.

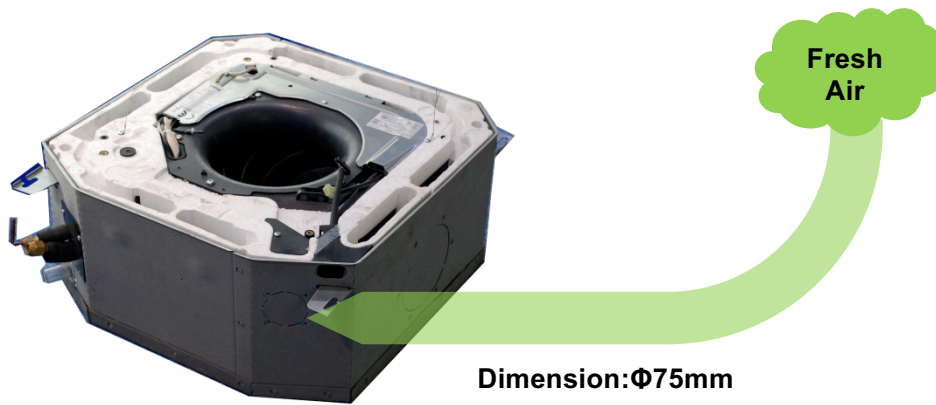

(5) Air passage function

- Reserves the space for air outlet from the side of indoor unit; It's availed to connect air duct from the two sides to the nearby small rooms.

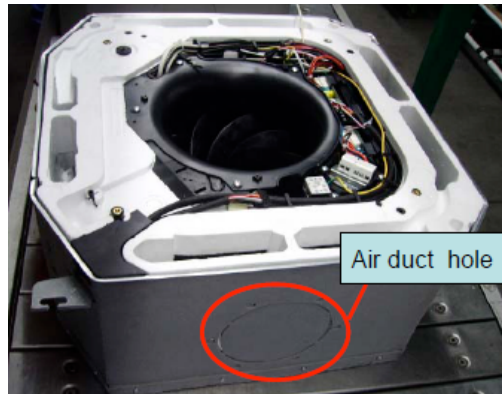

2.2 Console

(1) Consumes up to 30% less energy than non-inverter units

- DC inverter compressor
- indoor fan motor adopts DC motor

(2) Achieves set temperature more quickly

- air supplying from top and bottom or from top only
- air inlet from four directions



(3) Compact unit body, space saving

- this unit body is very thin and harmonious with room. It is beautiful, elegant and space saving.
- lightweight and compact.

(4) Flexible installation.

- can be used for floor standing or lower wall applications
- as a floor standing floor model, it can be semi or fully recessed without loss of capacity.

(5) High efficiency filter

- built in Formaldehyde nemesis filter
- active-carbon and biological anti-virus filter is optional.

(6) Comfort

- flexible air blow: vertical auto swing and wide angle louvers ensure that warm air reaches the furthest corners of the room and increase the air flow coverage
- Low noise operation, lowest to 23Db
- Low starting power and precise room temperature adjustment

(7) Powerful mode can be selected for rapid cooling or heating.

(8) Easy cleaning grille and maintenance

(9) Indoor unit adopts DC motor, it has five level fan speed meet different requirements.

2.3 Duct

(1) Higher Static Pressure

- As a ducted air conditioner with medium static pressure, it has the widest static pressure range.
- The maximum static pressure reaches 160 Pa



(2) Constant air volume control

- For ordinary duct, when the static pressure exceeds the expected range, it is fairly difficult even for an experienced installer to calculate and adjust the air volume precisely.
- With constant air volume control technology, the duct will automatically adjust to perfect static pressure and keep constant air volume.

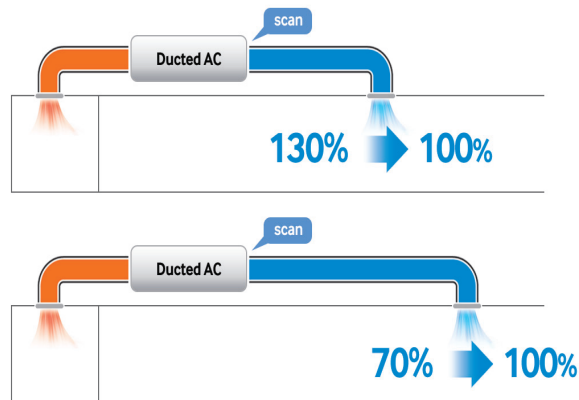

(3) Flexible Air Intake Way (Bottom side or Rear side)

- The frame size of air inlet in rear and bottom is the same. It's very easy to switch to match different application.

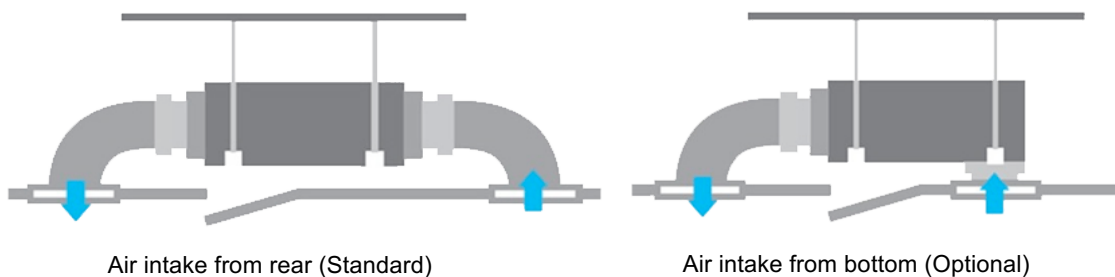

(4) Communication wire connection

- Duct uses two wires without polarity connection way, which almost has no mistake during the installation.



(5) Easy Clean

- With a larger window design, once the motor and the blower wheels have been detached, heat exchanger and water receiver tray in behind can be seen very clearly. Dust can be easily removed from the inside by vacuum

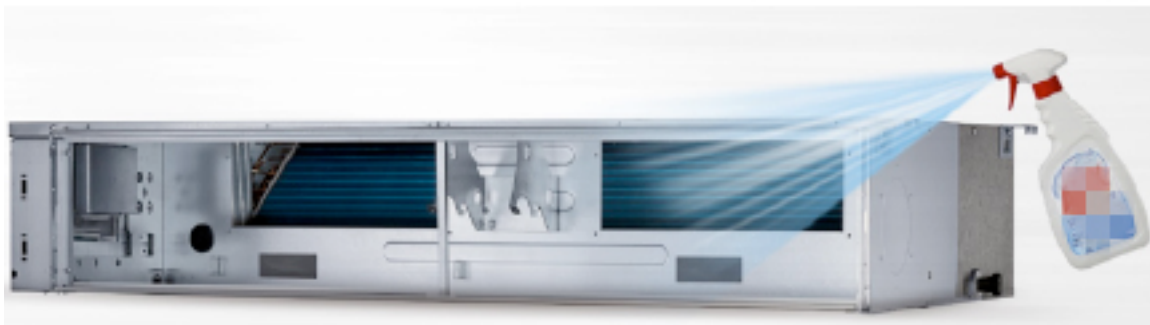

(6) Fresh air intake function(Optional)

- Install one duct from the reserved fresh-air intake to outdoor. Continually inhale the fresh air to improve the quality of the indoor air, fulfills air quality more healthy and comfortable.
- A ventilation motor (provided by the installer) can be installed inside the fresh air duct to improve the fresh air volume. There are reserved ports for this motor on main PCB (Standard for 3D inverter units, and only optional for DC inverter 53~160 units).

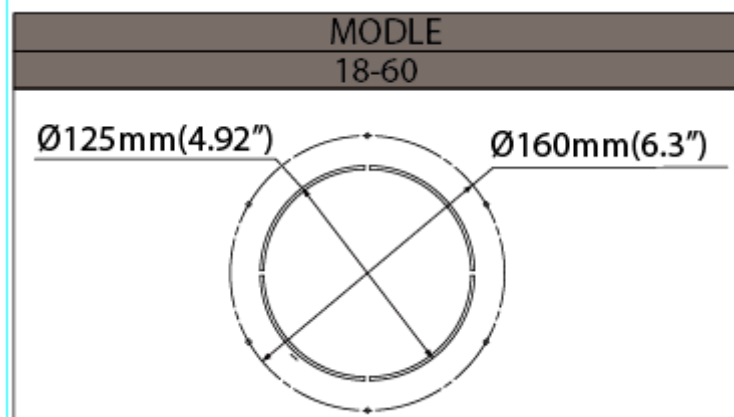

(7) Built-in drain pump (Optional)

- Built-in drain pump can lift the water to 750mm upmost, which widens the drainage piping range.

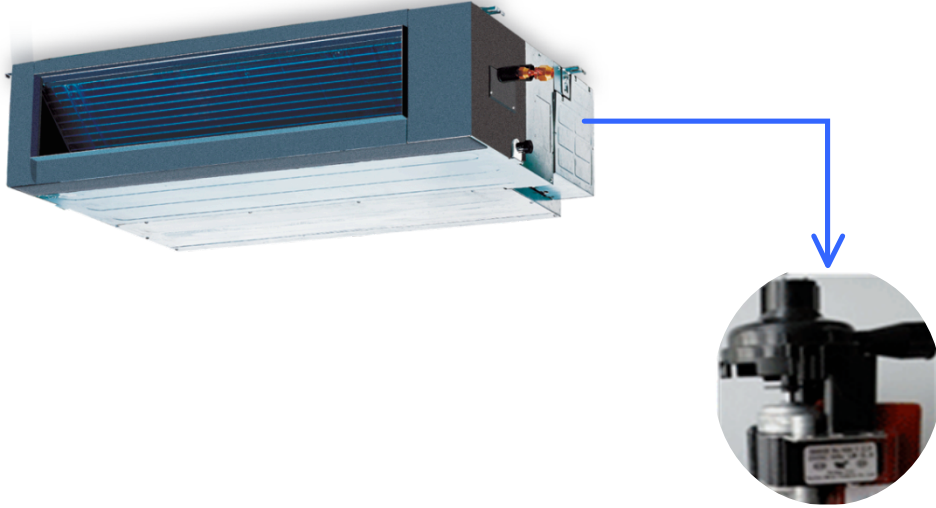
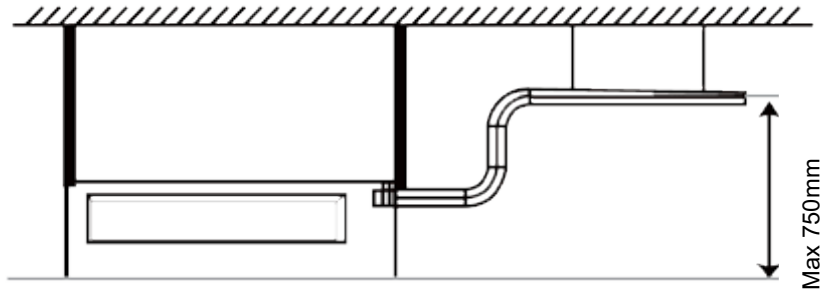

3. Dimensions

3.1 Four-way cassette type (compact):

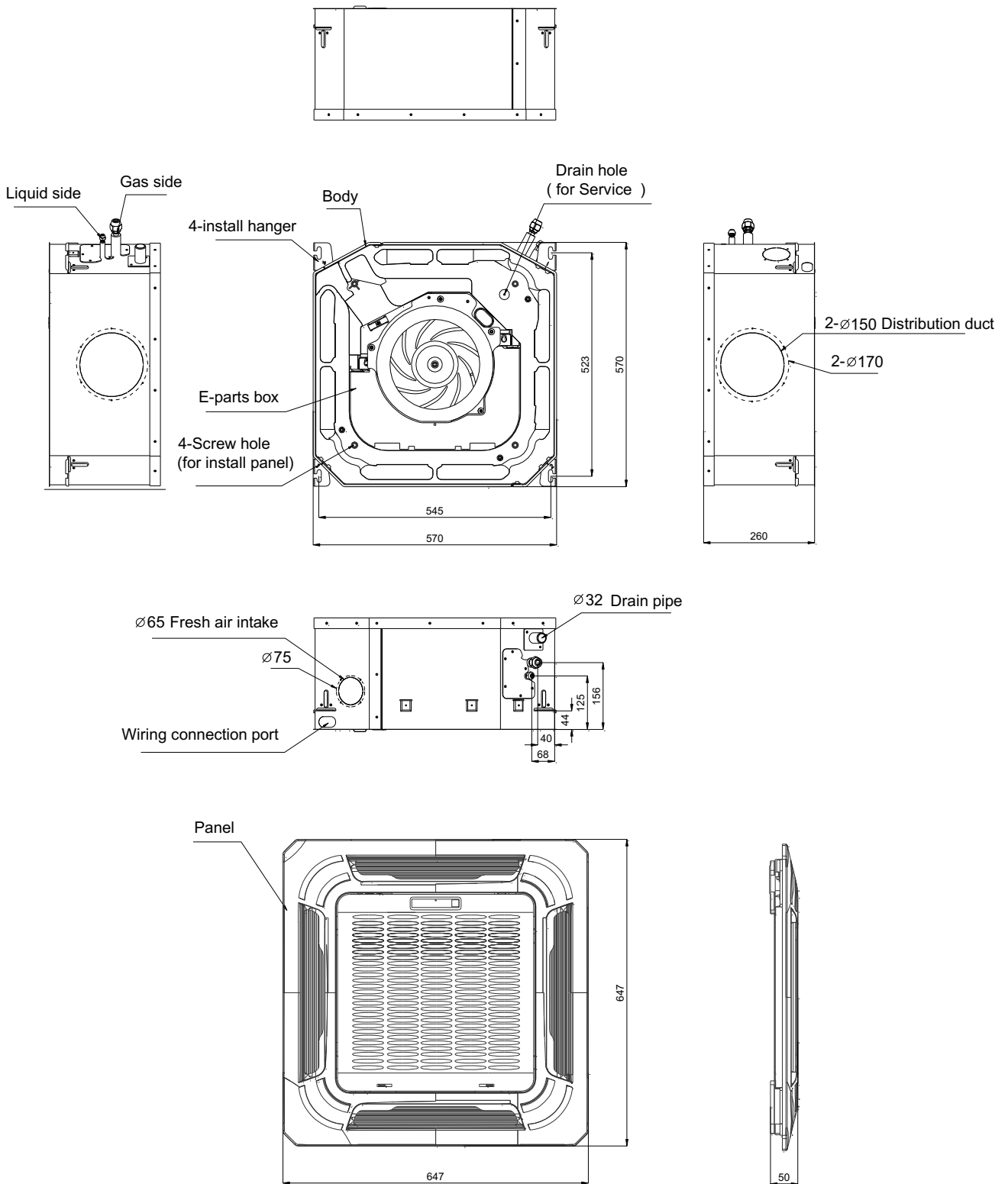

3.2 Console

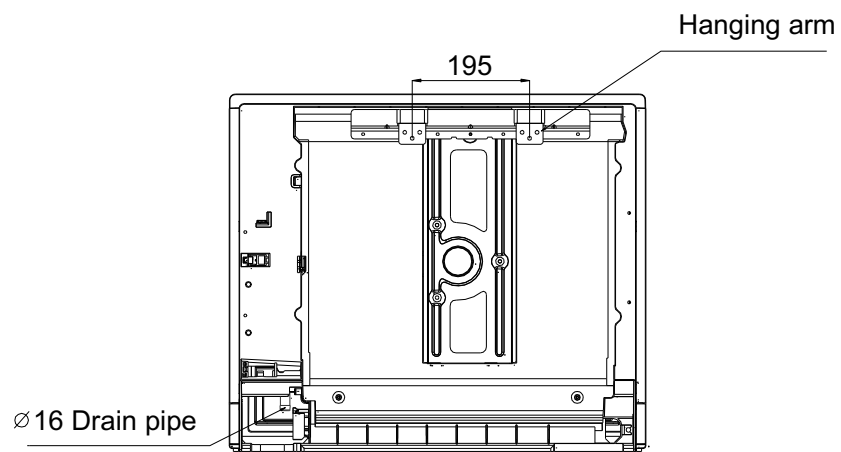
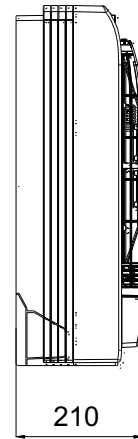
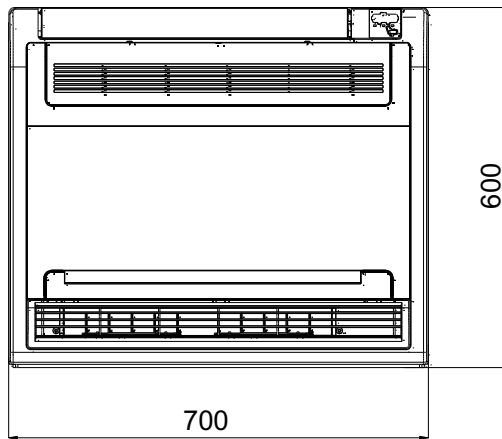
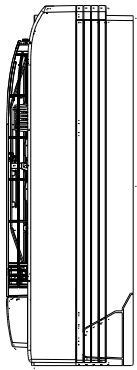
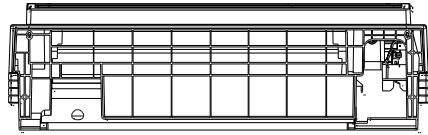

3.3 Duct

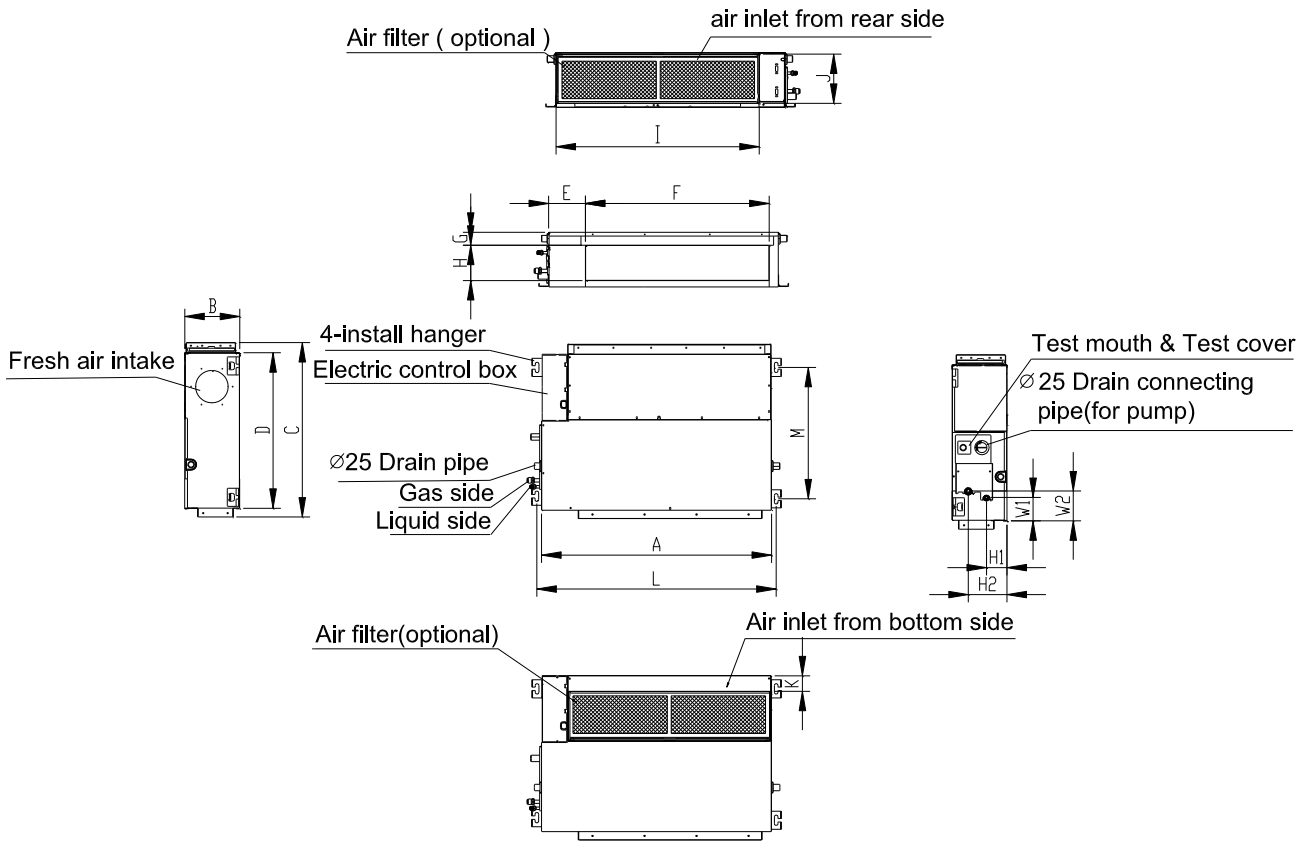

Model (KBtu/h)	unit	A	B	C	D	E	F	G	H	I	J	K	L	M	H1	H2	W1	W2
7/9/12	mm	700	200	506	450	137	537	30	152	599	186	50	741	360	84	140	84	84
18	mm	880	210	674	600	140	706	50	136	782	190	40	920	508	78	148	88	112

4. Service Space (unit: mm)

4.1 Four-way cassette (compact)

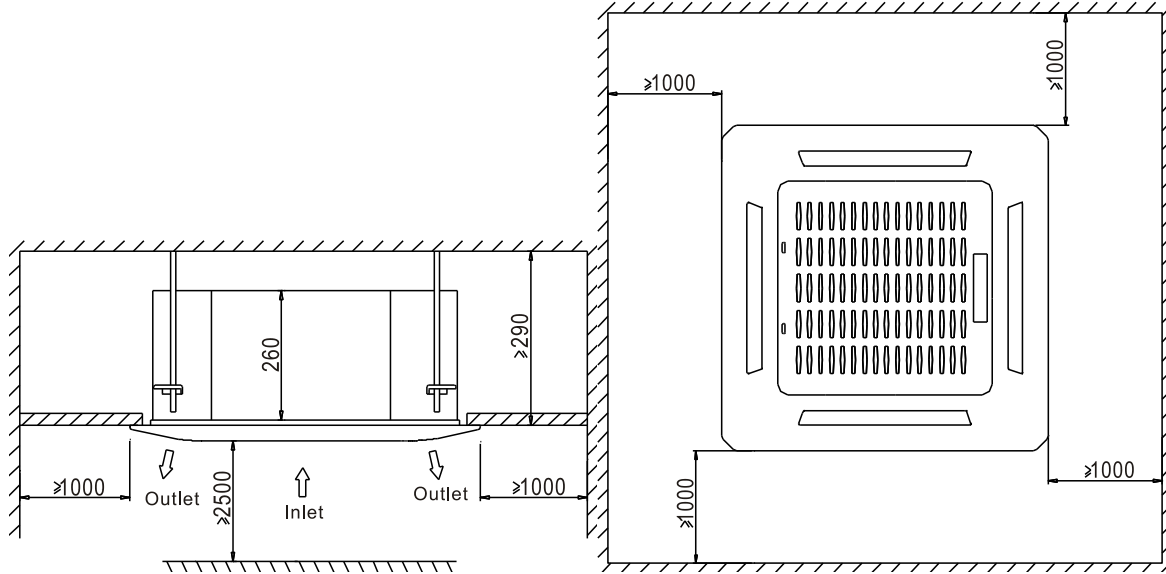

4.2 Duct

Ensure enough space required for installation and maintenance.

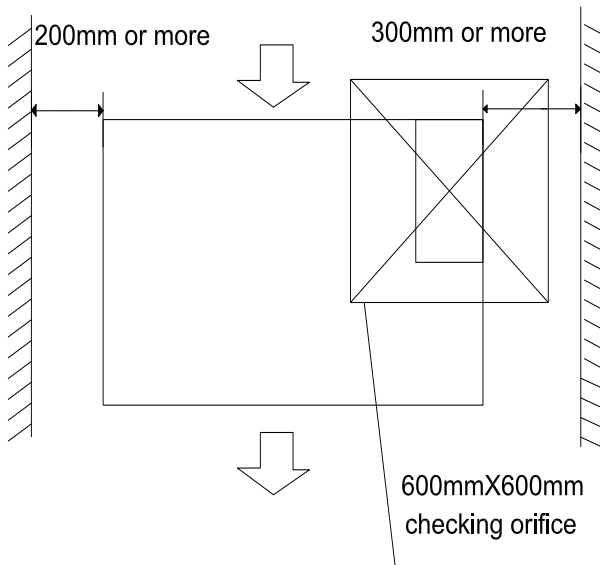

All the indoor units reserve the hole to joint the fresh air pipe. The hole size as following:

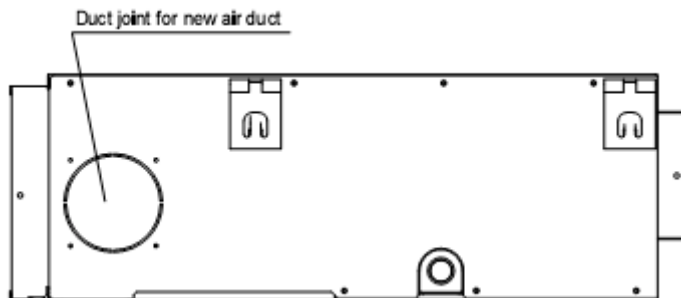

MODLE	
12-24	30-60
<p>Technical drawing of a circular grille for model 12-24. The diameter is $\varnothing 90\text{mm}$. The width and height of the grille are both 80mm.</p>	<p>Technical drawing of a circular grille for model 30-60. The outer diameter is $\varnothing 160\text{mm}$ and the inner diameter is $\varnothing 125\text{mm}$.</p>

4.3 Console

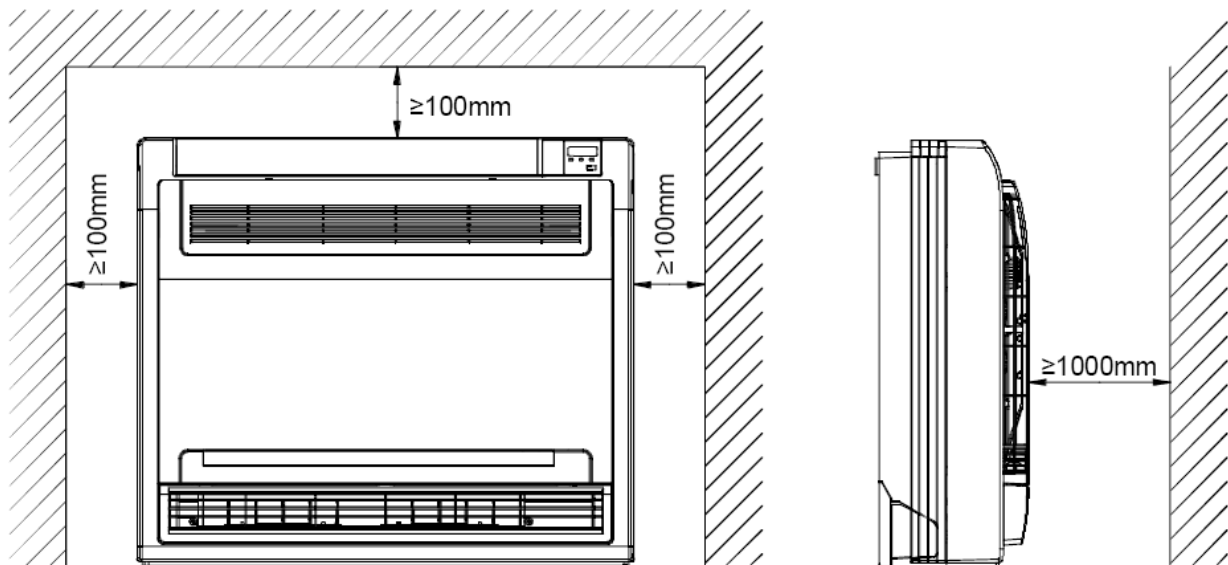

5. Wiring diagram

LV5MCI32-12WiFiR, LV5MCI32-18WiFiR

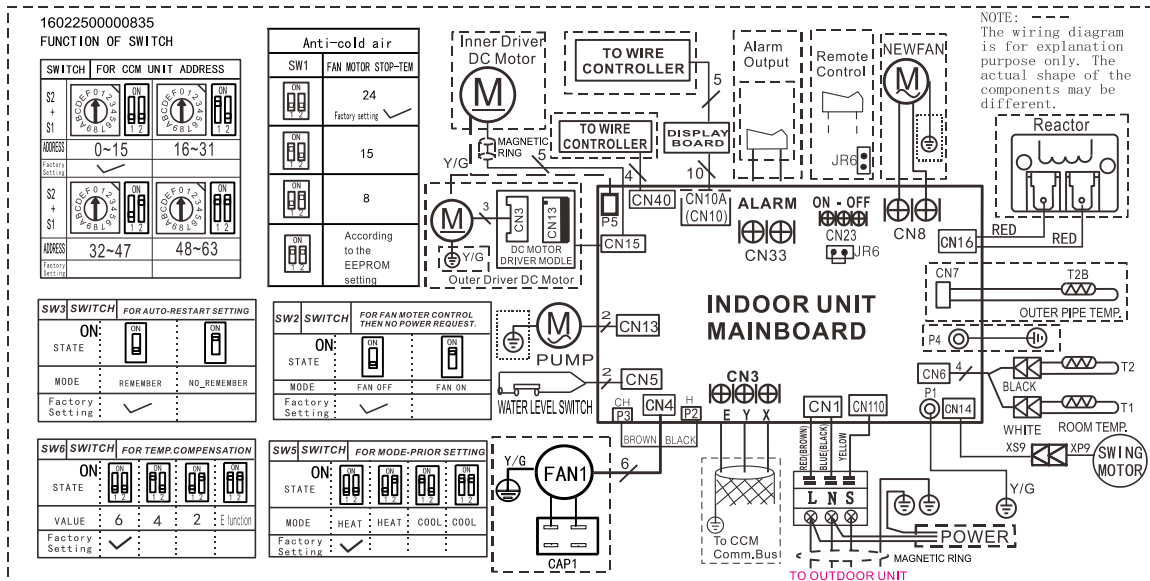

LV5MLI32-12

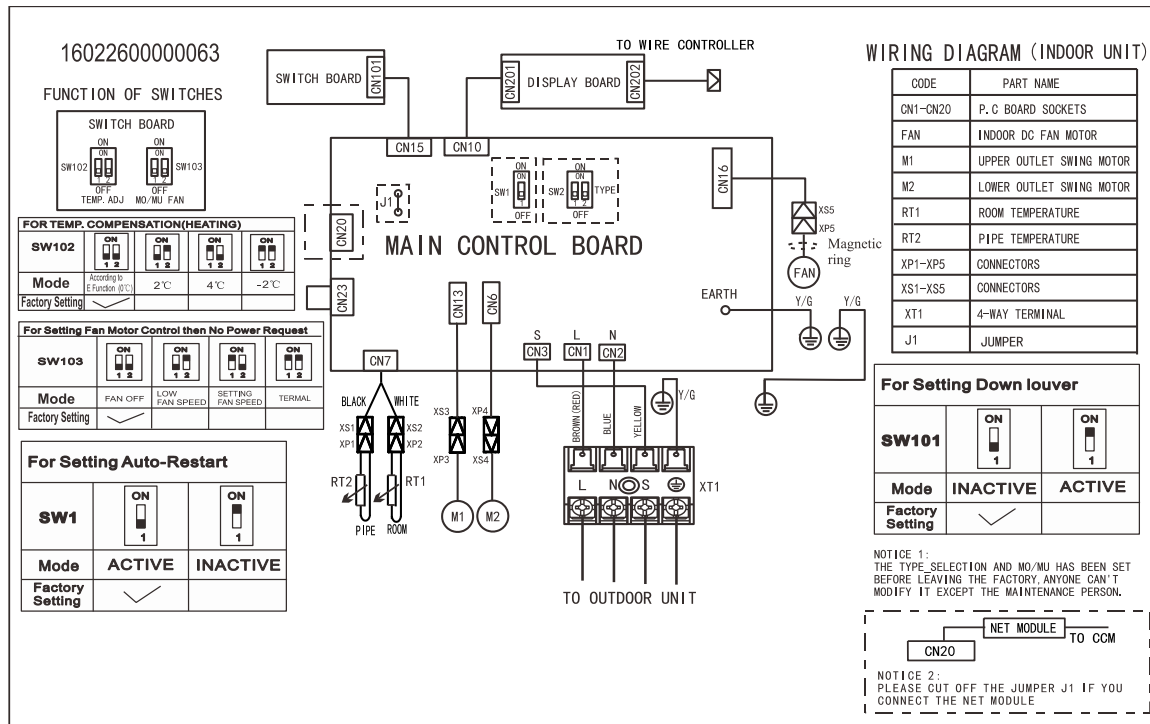

LV5MDI32-12WiFiR

1602300007861 WIRING DIAGRAM

FOR ANTI-COLD WIND				
SW1	<input type="checkbox"/> ON <input type="checkbox"/> 1 2	<input type="checkbox"/> ON <input type="checkbox"/> 1 2	<input type="checkbox"/> ON <input type="checkbox"/> 1 2	<input type="checkbox"/> ON <input type="checkbox"/> 1 2
TELO	24°C	15°C	8°C	EEPROM DEFAULT
FACTORY SETTING	<input checked="" type="checkbox"/>			

FOR SETTING FAN MOTOR CONTROL WHEN THERE IS NO DEMAND		
SW2	<input type="checkbox"/> ON <input type="checkbox"/> 1	<input type="checkbox"/> ON <input type="checkbox"/> 1
MODE	FAN OFF	FAN ON
FACTORY SETTING	<input checked="" type="checkbox"/>	

FOR SETTING AUTO-RESTART		
SW3	<input type="checkbox"/> ON <input type="checkbox"/> 1	<input type="checkbox"/> ON <input type="checkbox"/> 1
MODE	AUTO-RESTART	NOT AUTO-RESTART
FACTORY SETTING	<input checked="" type="checkbox"/>	

FOR TEMP. COMPENSATION(HEATING)				
SW6	<input type="checkbox"/> ON <input type="checkbox"/> 1 2	<input type="checkbox"/> ON <input type="checkbox"/> 1 2	<input type="checkbox"/> ON <input type="checkbox"/> 1 2	<input type="checkbox"/> ON <input type="checkbox"/> 1 2
CODE	6°C	2°C	4°C	EEPROM DEFAULT
FACTORY SETTING	<input checked="" type="checkbox"/>			

FOR SETTING NETADDRESS				
S1+S2	<input type="checkbox"/> ON <input type="checkbox"/> 1 2	<input type="checkbox"/> ON <input type="checkbox"/> 1 2	<input type="checkbox"/> ON <input type="checkbox"/> 1 2	<input type="checkbox"/> ON <input type="checkbox"/> 1 2
CODE	0-F	0-F	0-F	0-F
NETADDRESS	0-15	16-31	32-47	48-63
FACTORY SETTING	<input checked="" type="checkbox"/>			

FOR SETTING POWER			
ENC1	<input type="checkbox"/> 0	<input type="checkbox"/> 1	<input type="checkbox"/> 2
CODE	0	1	2
POWER	20	26	32-35
FACTORY SETTING	ACCORDING TO RELATED MODEL.		

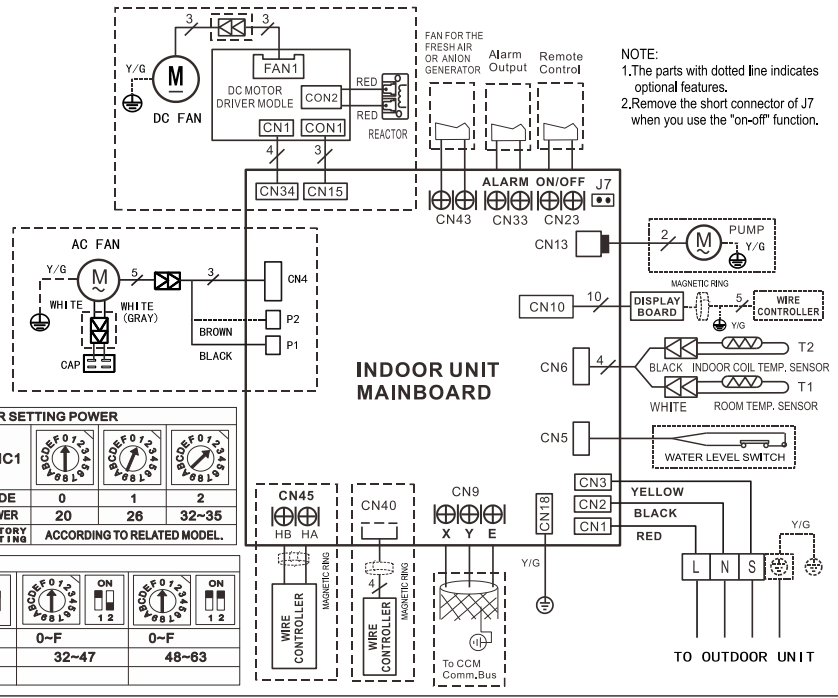

NOTE:
1. The parts with dotted line indicates optional features.
2. Remove the short connector of J7 when you use the "on-off" function.

6. Static Pressure (Duct)

LV5MDI32-12WiFiR

Air flow rate(m³/h)
(no filter)

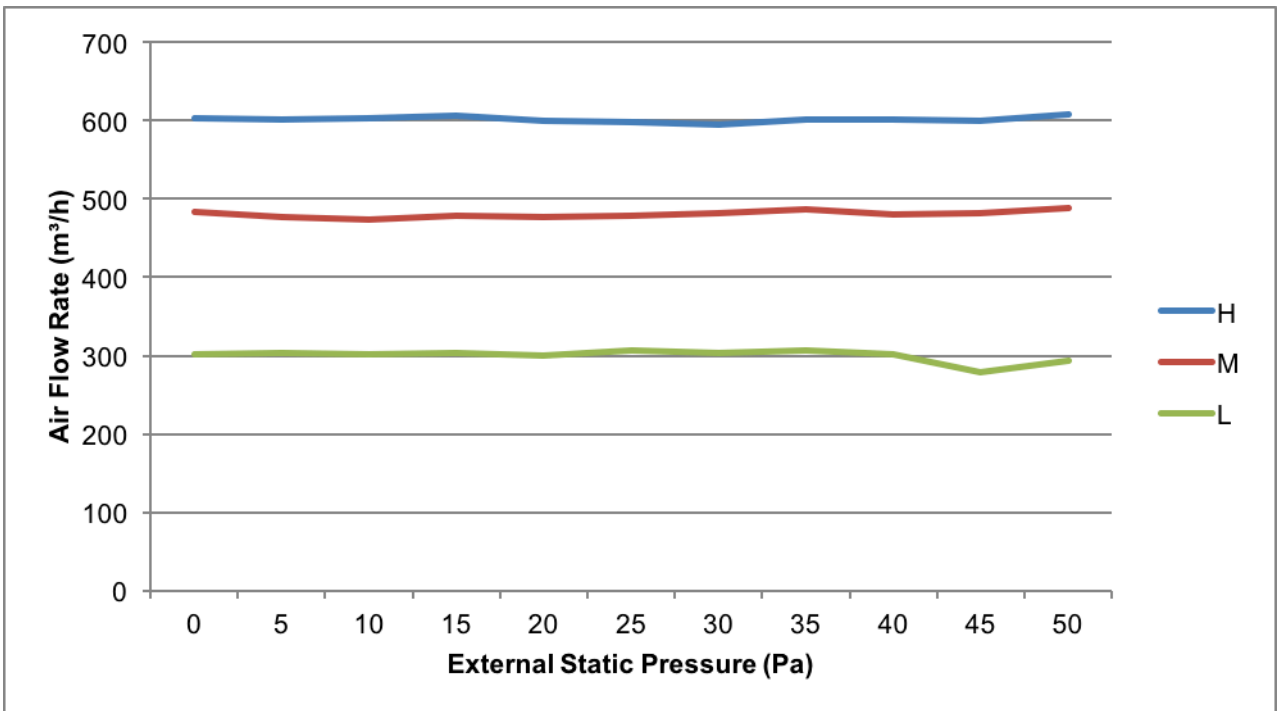
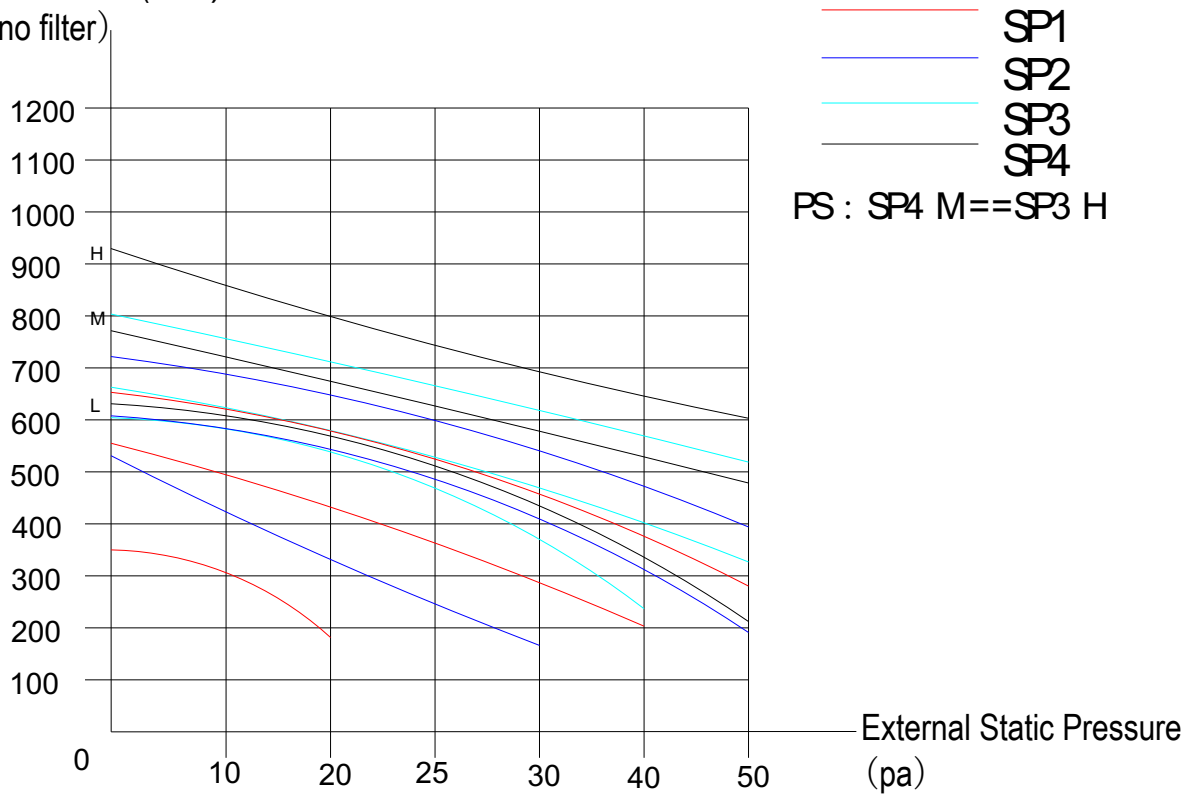

7. Operation temperature range

Mode \ Temperature	Cooling operation	Heating operation	Drying operation
Room temperature	17°C~32°C	0°C~30°C	17°C~32°C
Outdoor temperature	0°C~50°C	-15°C~24°C	0°C~50°C
	(-15°C~50°C: For the models with low temperature cooling system)		

CAUTION:

1. If the air conditioner is used beyond the above conditions, certain safety protection features may come into operation and cause the unit to operate abnormally.
2. The room relative humidity should be less than 80%. If the air conditioner operates beyond this figure, the surface of the air conditioner may attract condensation. Please set the vertical air flow louver to its maximum angle (vertically to the floor), and set HIGH fan mode.
3. The optimum performance will be achieved during this operating temperature zone.

8. Electronic function

8.1 Abbreviation

T1: Indoor room temperature

T2: Indoor evaporator temperature

T2B: Coil temperature of indoor heat exchanger outlet(This sensor is located in outdoor unit)

T3: Coil temperature of outdoor heat exchanger

T4: Outdoor ambient temperature

T5: Compressor discharge temperature

Ts: Setting temperature

8.2 Icon explanation on indoor display board

8.2.1 Four-way cassette (compact)

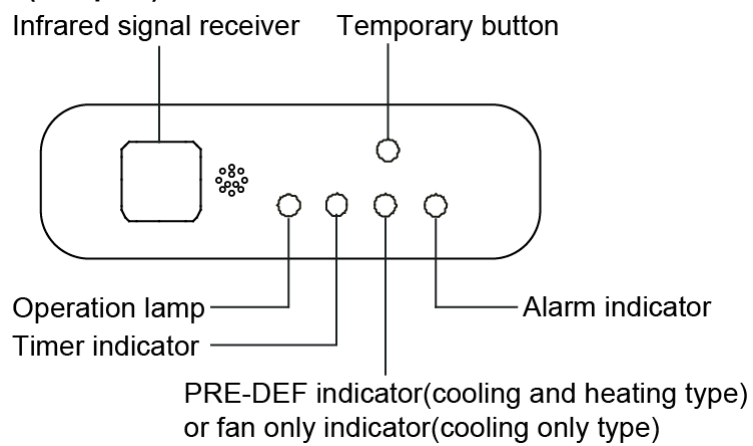

8.2.2 A6 Duct

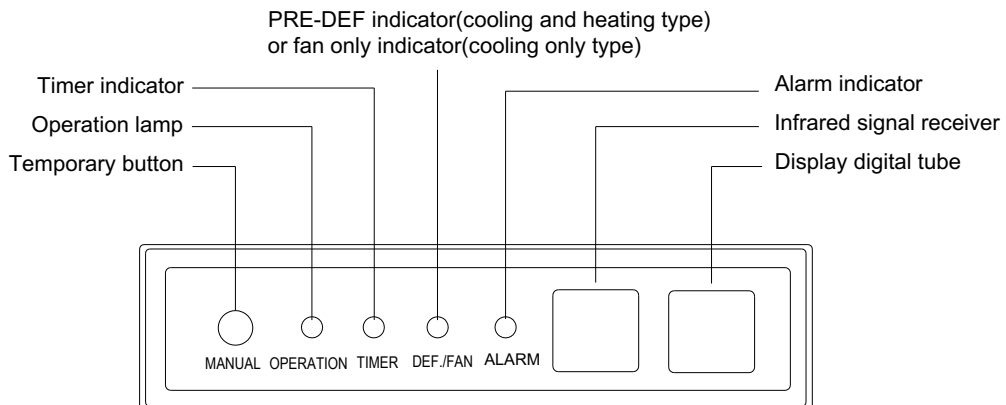

8.2.3 Console

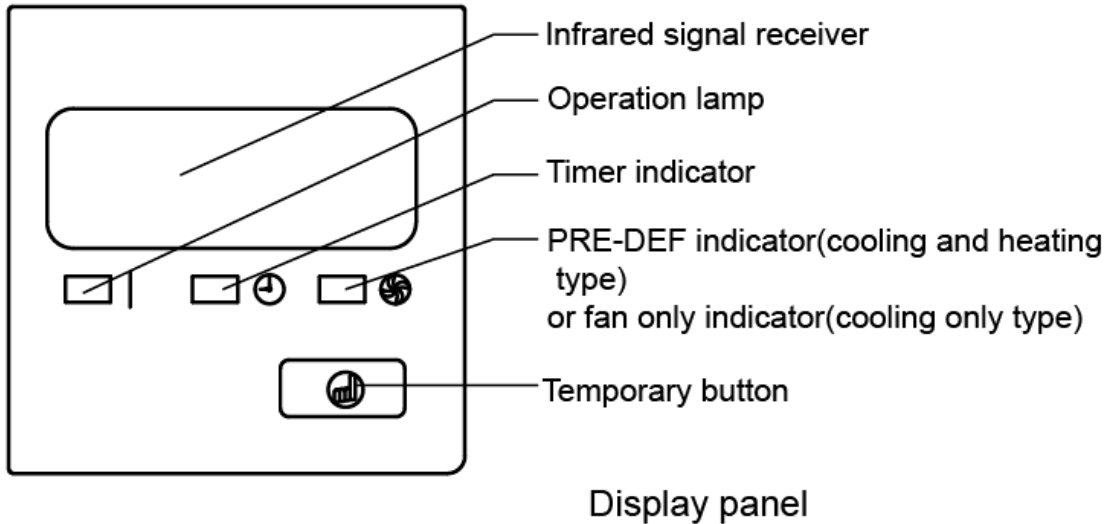

8.3 Main Protection

8.3.1 Three minutes delay at restart for compressor.

8.3.2 Sensor protection at open circuit and breaking disconnection.

8.3.3 Indoor fan delayed open function

---When system starts up, the louver will be active immediately, and the indoor fan will open after certain time.

---If the system runs in heating mode, the anti-cold wind function has priority.

8.3.4 Fan speed is out of control (For the units used DC fan motor)

For console:

When indoor fan speed keeps too low (300RPM) for certain time, the unit will stop and the LED will display the failure.

For other models:

When indoor fan speed keeps too low (lower than 300 RPM) for 50s, the indoor fan will shut off and restart 30s later, if protection happened 3 times when fan motor restart continuously, the unit will stop and the LED will display the failure.

8.3.5 Inverter module protection

The Inverter module has a protection function about current, voltage and temperature. If these protections happen, the corresponding code will display on indoor unit and the unit will stop working.

8.4 Operation Modes and Functions

8.4.1 Fan-only mode

(1) Outdoor fan and compressor stop.

(2) For Console: Indoor fan can be set to high/med/low/breeze, for other models: Indoor fan can be set to high/med/low/auto.

(3) The louver operates same as in cooling mode.

(4) Auto fan in fan-only mode acts as follow:

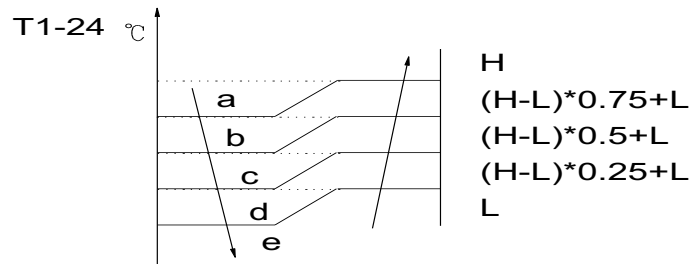

8.4.2 Cooling mode

8.4.2.1 Outdoor fan running rules

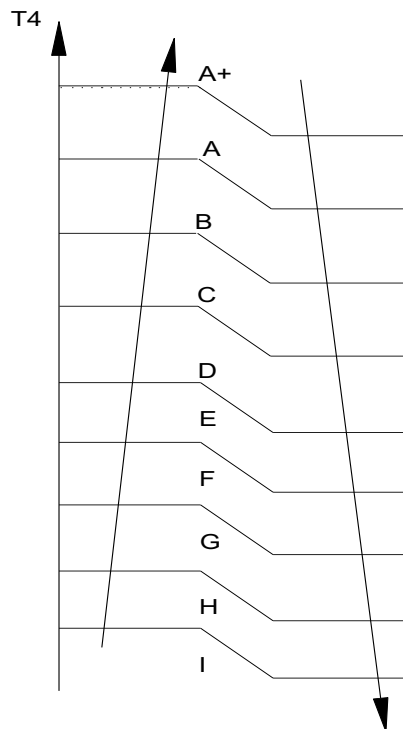

While A,B,C...means different fan speed of outdoor unit.

8.4.2.2 Indoor fan running rules

In cooling mode, indoor fan runs all the time and the speed can be selected as high, medium, low and auto.

When the compressor is running, the indoor fan is controlled as below:

Setting fan speed	T1-Td °C (°F)	Actual fan speed
H	A	H+ (H+=H+G)
	B	H (=H)
	C	H- (H-=H-G)
M	D	M+ (M+=M+Z)
	E	M (M=M)
	F	M- (M-=M-Z)
L	G	L+ (L+=L+D)
	H	L (L=L)
	I	L- (L-=L-D)

The auto fan acts as below rules:

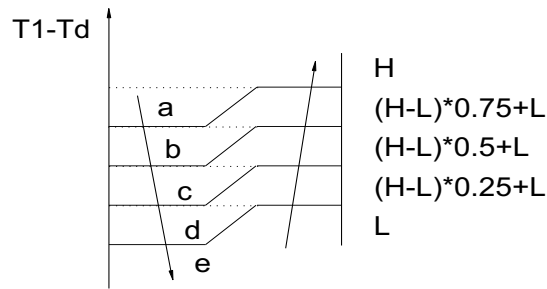

8.4.2.3 Evaporator low temperature T2 protection

When $T_2 < 4^\circ\text{C}$ for 250s or $T_2 < 0^\circ\text{C}$, the indoor has no capacity demand and resume till $T_2 > 8^\circ\text{C}$

8.4.3 Dry mode

8.4.3.1 Indoor fan speed is fixed at breeze and can't be changed. The louver angle is the same as in cooling mode.

8.4.3.2 Low indoor room temperature protection

In drying mode, if room temperature is lower than 10°C , the indoor fan will stop and not resume until room temperature exceeds 12°C .

8.4.3.3 Evaporator anti-freezing protection and condenser high temperature protection are active and the same as that in cooling mode.

8.4.3.4 The outdoor fan operates the same as in cooling mode.

8.4.4 Heating mode

8.4.4.1 Outdoor fan running rules

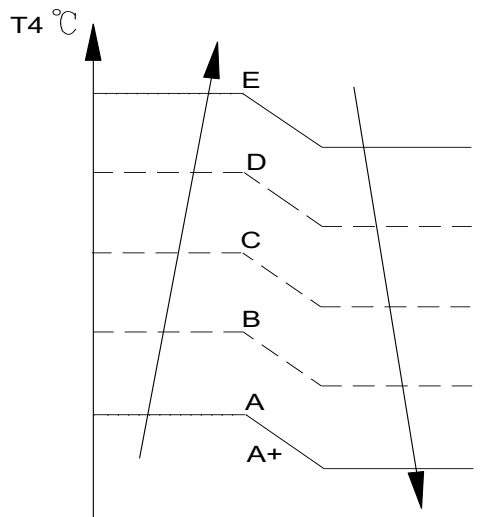

8.4.4.2 Indoor fan running rules

In heating mode, indoor fan can be selected as high, medium, low and auto. The anti-cold-wind function has the priority.

When the compressor is running, the indoor fan is controlled as below:

Setting fan speed	T1-Td°C	Actual fan speed
H		H- (H=H-G)
		H (=H)
		H+(H+=H+G)
M		M-(M=M-Z)
		M(M=M)
		M+(M+=M+Z)
L		L-(L=L-D)
		L(L=L)
		L+(L+=L+D)

If the compressor stops caused by the room temperature rising, the indoor fan will be forced to run 127 seconds with breeze. During this period, the anti-cold-wind is disabled.

Auto fan action in heating mode:

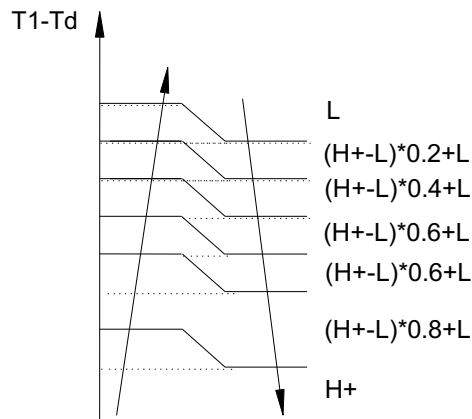

8.4.4.3 High evaporator coil temp.T2 protection:

If $T_2 > 63^\circ\text{C}$, the indoor unit has no capacity demand and resume till 48°C .

8.4.4.4 Prevent Over-Heating

In heating mode, when the indoor unit has no capacity requirement due to indoor room temperature increased, the Indoor fan will run in super breeze. (Anti-cold wind function has the priority)

8.4.4.5 Defrosting mode:

Condition of defrosting:

AC will enter the defrosting mode according to the value of temp. of T3 and the value range of temp. change of T3 and also the compressor running time.

Condition of ending defrosting:

If any one of the following items is satisfied, the defrosting will finish and the machine will turn to normal heating mode.

----T3 rises to be higher than $TCDE1^\circ\text{C}$.

----T3 keeps to be higher than $TCDE2^\circ\text{C}$ for 80 seconds.

---The machine has run for 10 minutes in defrosting mode.

Defrosting action:

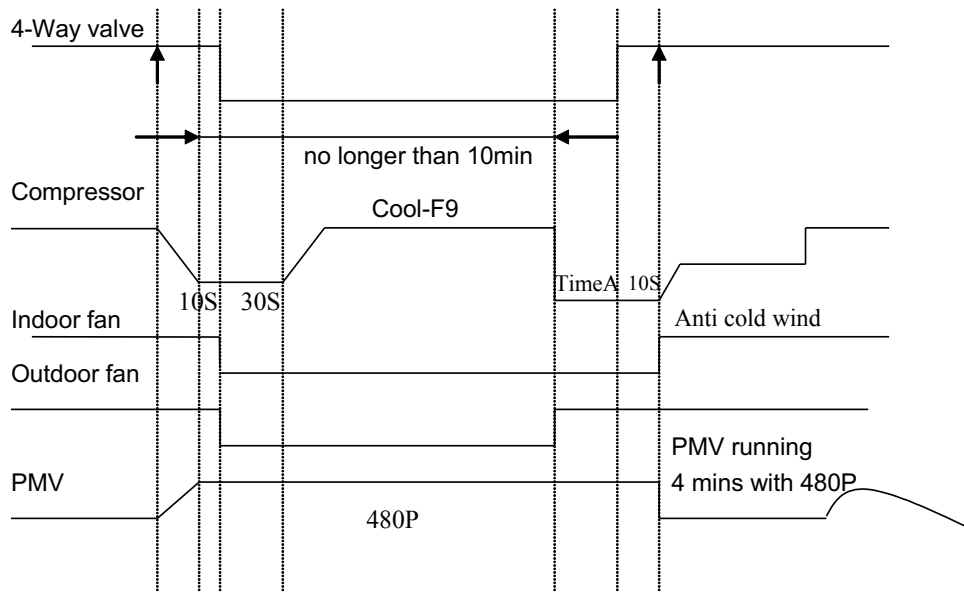

8.4.5 Auto-mode

This mode can be chosen by remote controller and the setting temperature can be changed between 17~30°C.

In auto mode, the machine will choose cooling, heating or fan-only mode according to the difference between T1 and TS.

For other models:

T1-TS	Running mode
$T1-TS > 2^{\circ}\text{C}$	Cooling
$-2 < T1-TS \leq 2^{\circ}\text{C}$	Fan-only
$T1-TS \leq -2^{\circ}\text{C}$	Heating

Indoor fan will run at auto fan of the relevant mode.

The louver operates same as in relevant mode.

If the machine switches mode between heating and cooling, the compressor will keep stopping for 15 minutes and then choose mode according to T1-Ts.

If the setting temperature is modified, the machine will choose running function again.

8.4.6 Forced operation function

8.4.6.1 Enter forced operation function:

Press the touch button continually, the AC will run as below sequence:

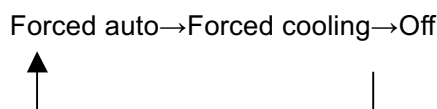

When the machine is off, pressing the touch button will carry the machine to forced auto mode, after this, if pressing the button once again, the machine will turn into forced cooling mode.

In forced cooling mode, pressing touch button will turn off the machine.

8.4.6.2 In forced operation mode, all general protections and remote control are available.

8.4.6.3 Operation rules:

Forced cooling mode:

The compressor runs at F2 frequency and indoor fan runs as breeze. After running for 30 minutes, the machine will turn to auto mode as 24°C setting temperature.

Forced auto mode:

The action of forced auto mode is the same as normal auto mode with 24°C setting temperature.

8.4.6.4 When there's indoor unit running in forced cooling, it is the master forced cooling unit. Other indoor units will run at forced cooling mode too and they will be the slave forced cooling units. The slave forced cooling units can not quit forced cooling mode until the master forced cooling unit quit, and turn to cooling mode at low speed with 24°C setting temperature.

7.4.6.5 The slave forced cooling units will not be controlled by other signals.

8.4.7 Timer Function

8.4.7.1 Timing range is 24 hours.

8.4.7.2 Timer on. The machine will turn on automatically when reaching the setting time.

8.4.7.3 Timer off. The machine will turn off automatically when reaching the setting time.

8.4.7.4 Timer on/off. The machine will turn on automatically when reaching the setting "on" time, and then turn off automatically when reaching the setting "off" time.

8.4.7.5 Timer off/on. The machine will turn off automatically when reaching the setting "off" time, and then turn on automatically when reaching the setting "on" time.

8.4.7.6 The timer function will not change the AC current operation mode. Suppose AC is off now, it will not start up firstly after setting the "timer off" function. And when reaching the setting time, the timer LED will be off and the AC running mode has not been changed.

8.4.7.7 The setting time is relative time.

8.4.8 Sleep mode

8.4.8.1 The sleep function is available in cooling, heating or auto mode.

8.4.8.2. Operation process in sleep mode is as follow.

After pressing ECONOMIC or SLEEP button on controller, the machine will turn into sleep mode.

When cooling, The set temperature rise 1°C per hour (be lower than 30°C). Two hours later, the set temperature will maintain as a constant and the fan speed is kept at low speed.

When heating, The set temperature decrease 1°C per hour (be higher than 17°C). Two hours later, the set temperature will maintain as a constant and the fan speed is kept at low speed (Anti-cold function takes precedence over all).

When auto, After an hour running under economic mode, if it is under cooling mode the set temp will rise 1°C, if it is under heating mode the set temp will decrease 1°C, if it is under fan-only mode the set temp will be

changeless; the condition will be the same after the air conditioner running under economic mode after 2 hours, and during the next time the set temp do not change.

8.4.8.3 Operation time in sleep mode is 7 hours. After 7 hours the AC quits this mode and the AC will turn off.

8.4.8.4 Timer off and remote controller off signals have the priority compared with sleep function.

8.4.9 Auto-Restart function

The indoor unit is equipped with auto-restart function, which is carried out through an auto-restart module. In case of a sudden power failure, the module memorizes the setting conditions before the power failure. The unit will resume the previous operation setting (not including swing function) automatically after 3 minutes when power returns.

If the memorization condition is forced cooling mode, the unit will run in cooling mode for 30 minutes and turn to auto mode as 24°C setting temp.

If AC is off before power off and AC is required to start up now, the compressor will have 1 minute delay when power on. Other conditions, the compressor will have 3 minutes delay when restarts.

8.4.10 Drain pump control (For Duct & Cassette)

Adopt the water-level switch to control the action of drain pump.

Main action under different condition :(every 5 seconds the system will check the water level one time)

1. When the A/C operates with cooling (including auto cooling) and forced cooling mode or dry mode, the pump will start running immediately and continuously, till stop cooling or dry or no capacity demand.
2. Once the water level increase and up to the control point, LED will alarm and the drain pump open and continue checking the water level. If the water level falls down below the control point (drain pump delay close 1 minute) and operate with the last mode. Otherwise the entire system stop operating (including the pump) and LED remain alarming after 3 minutes,

8.4.11 Follow me (optional)

- 1) If the indoor PCB receives the signal which results from pressing the FOLLOW ME button on remote controller, the buzzer will emit a sound and this indicates the follow me function is initiated. But when the indoor PCB receives signal which sent from remote controller every 3 minutes, the buzzer will not respond. When the unit is running with follow-me function, the PCB will control the unit according to the temperature from follow-me signal, and the temperature collection function of room temperature sensor will be shielded, and the error detective function of room temperature sensor will be still invalid.
- 2) When the follow-me function is available, the PCB will not respond according to the setting temperature from follow-me signal every 3 minutes.
- 3) The PCB will take action to the mode change information from remote controller signal, and the follow-me function will be turned off. (if the wired remote controller does not initiate follow me function).
- 4) When the unit is running with follow-me function, if the PCB doesn't receive any signal from remote controller for 7 minutes or pressing FOLLOW ME button again, the follow-me function will be turned off automatically, and the temperature collection function of room temperature sensor will be available, the

PCB will control the unit according to the room temperature detected from its own room temperature sensor and setting temperature.

- 5) When the indoor PCB receives the follow-me signal from wired remote controller, the control is the same as that from wireless remote controller, but buzzer will not emit a sound. When the PCB receives turning-off follow-me signal from wired remote controller, the unit will quit follow-me function at once. The follow-me function controlled by wired remote controller prevails that by wireless remote controller.

8.4.12 Mode conflict

The indoor units can not work cooling mode and heating at same time.

Heating mode has a priority.

(1) Definition

	Cooling mode	Heating Mode	Fan	Off
Cooling mode	No	Yes	No	No
Heating Mode	Yes	No	Yes	No
Fan	No	Yes	No	No
Off	No	No	No	No

No: No mode conflict;

Yes: Mode conflict

(2) Unit action

- In case of one Indoor unit working in cooling mode or fan mode, and another indoor unit is set to heating mode, the indoor unit working in cooling mode or fan mode will change to off. The outdoor unit will change to heating mode after compressor stop 3 minutes. .
- In case of one Indoor unit working in heating mode, and another indoor unit is set to cooling mode or fan mode, the indoor unit setting to cooling mode or fan mode will change to stand by. The outdoor unit will continue working in heating mode.

If heating mode stops (not including the indoor unit in heating mode reaching the set temperature), 3 minutes after the outdoor unit restarts and works in cooling mode or fan-only mode.



AIR CONDITIONING SYSTEMS

MULTI SPLIT SYSTEM

Inventor je členem skupiny BEIJER REF

Distributor pro
Českou republiku:

BEIJER REF Czech s.r.o.
Obchodní 107
251 01 Čestlice
Tel: +420 379 302 111
www.beijerref.cz
info@beijerref.cz

Distributor pro
Slovenskou republiku:

BEIJER REF Slovakia s.r.o.
Ivánska cesta 33
821 04 Bratislava
Tel: +421 918 502 792
www.beijerref.sk
info@beijerref.sk

